



CATÁLOGO
GENERAL

20
26

CONTENIDO

01 AEROKLAS 03

05 TJM 20

02 CARRYBOY 08

06 TRAKKO 23

03 FLASHCOVER 12

07 TRAKKO FORCE 28

04 REALTRUCK 18





AEROKLAS

CAJA

MULTIUSOS TANK



HECHO EN
TAILANDIA



SEGURIDAD
ASEGURADA



COMPATIBILIDAD
MULTIMODELO



LIGERO Y
RESISTENTE



CAPACIDAD 190 L



ENSAMBLE RÁPIDO

TALLA XL

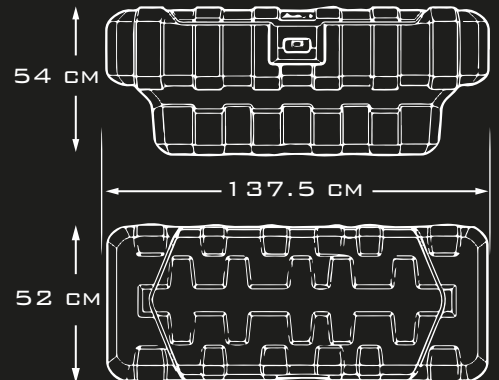

ANCHO	LARGO	ALTO
54 CM	137.5 CM	52 CM

COD:500

P. TOLVA

PROTECTOR DE TOLVA AEROKLAS

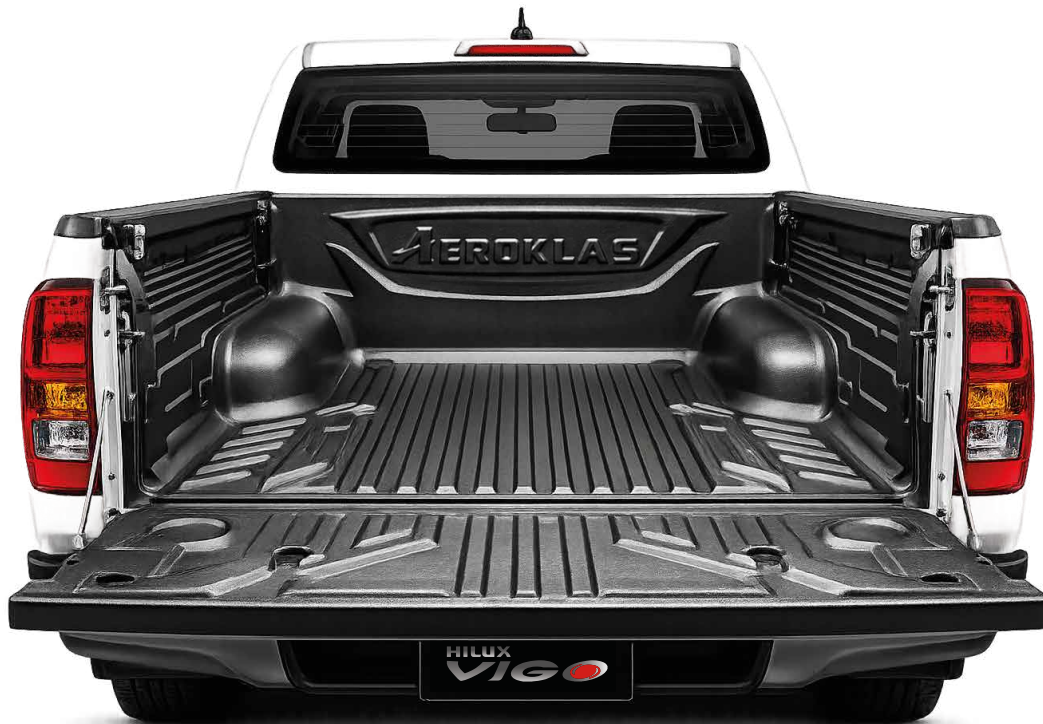

HECHO EN
TAILANDIA



AJUSTE
EXACTO



RESISTENTE
Y LIGERO

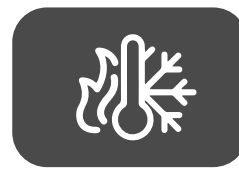

RESISTENCIA
TERMICA



GANCHO CROMADO



HECHO DE (HDPE) Y (PP)

MODELOS COMPATIBLES



MODELO L200 (2025)

COD: 316



L200 (2015 -2024)

COD: 397



MAZDA BT50 2025

COD: 467



NISSAN NAVARA 4X4

COD: 482



NP 300 (2024)

COD: 484



AEROKLAS



CARRYBOY

CASETA

CARRYBOY SR5



**HECHO EN
TAILANDIA**



**AJUSTE
EXACTO**



**POTENTES
LUCES**

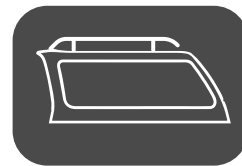

**BARRAS DE
TECHO**



VIDRIO CORREDIZO



LUZ LED INCORPORADA

COMPATIBLE CON



**TOYOTA HILUX REVO
COD: 503**

TAPAS

CARRYBOY SV



**HECHO EN
TAILANDIA**



**AJUSTE
EXACTO**



**POTENTES
LUCES**



**APERTURA
DE 45°**



ESPACIO PARA BARRAS



LUZ LED INCORPORADA

COMPATIBLE CON



FORD RANGER

COD: 505

CAJA

MULTIUSOS JUMBO BOX



**HECHO EN
TAILANDIA**



**SEGURIDAD
ASEGURADA**



**COMPATIBILIDAD
MULTIMODELO**



**ACABADO
PLATEADO**



GRAN CAPACIDAD



SEGURIDAD TOTAL

COD:504

MEDIDAS

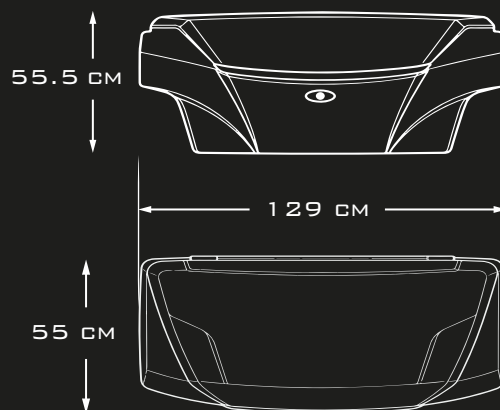

ANCHO	LARGO	ALTO
55 CM	129 CM	55.5 CM



FLASH
COVER

CAPOTA

MARÍTIMA FLASH COVER

DISTRIBUIDOR OFICIAL PARA PERU Y BOLIVIA



**HECHO EN
BRASIL**



**RESISTENTE
A RAYOS UV**



**PROTECCIÓN
DURADERA**

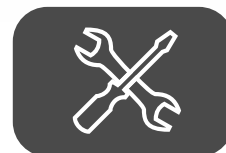

**AJUSTE
EXACTO**

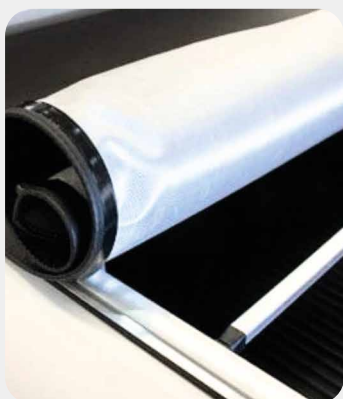

TENSORES



SISTEMA DE BLOQUEO



LONA - ACABADO

MODELOS COMPATIBLES



DODGE RAM 2500

COD: 173



SAVEIRO (2014)

COD: 175



AMAROK EXTREME

COD: 176



SSANGYONG MUSSO

COD: 178



RENAULT (2021-2025)

COD: 180



RANGER LIMITED 2012

COD: 214

MODELOS COMPATIBLES



MADZA NEW BT-50

COD: 341



SHARK (SIN BARRAS)

COD: 409



NEW L200 (2025)

COD: 410



SHARK (CON BARRAS)

COD: 411



RAM 1500 CD (2009)

COD: 444



KIA TASMÁN (2025)

COD: 493

MODELOS COMPATIBLES



TOYOTA HILUX REVO

COD: 208



RAM RAMPAGE CD 23

COD: 394



**FLASH
COVER**

TAPAS

TRIFOLD FLASH COVER



**HECHO EN
BRASIL**

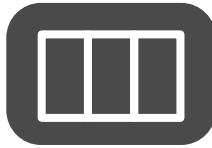

**APERTURA
TRIFOLD**



**PROTECCIÓN
DURADERA**

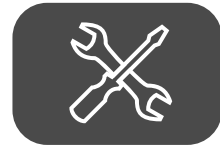

**AJUSTE
EXACTO**



**FÁCIL INSTALACIÓN
Y USO**

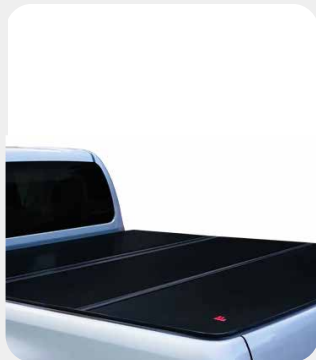

**RESISTENTE
Y LIGERO**

MODELOS COMPATIBLES



**TOYOTA HILUX REVO
COD: 494**



**NEW L200 (2025)
COD: 495**



 **REALTRUCK**

BAK REVOLVER

TAPA RETRACTIL X4S



HECHO EN
E.E.U.U.



RESISTENTE
A RAYOS UV



PROTECCIÓN
DURADERA



AJUSTE
EXACTO



PROTECCIÓN INTERNA



100% IMPERMEABLE

COMPATIBLE CON



TOYOTA
HILUX REVO

COD: 492



KIT DE INFLADOR

DE NEUMÁTICOS TJM



RESISTENTE
Y DURADERO



HECHO EN
AUSTRALIA

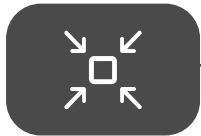

COMPACTO
Y LIGERO



DISEÑO
UNIVERSAL



COD:454



MEDICIÓN PRECISA



KIT COMPLETO

MOCHILA

DE EQUIPAMIENTO TJM



TEXTIL
DURADERO



HECHO EN
AUSTRALIA



RESISTENTE
AL SOL



DISEÑO
UNIVERSAL



COD:458



PRODUCTO PREMIUM



FUNDA IMPERMEABLE



TRAKKO

FIND THE ROAD

TRAKKO

JUEGO DE PISOS 5D

TPE

**MATERIAL
100% TPE**



**LIGERO Y
FLEXIBLE**



**A PRUEBA
DE AGUA**



**AJUSTE
EXACTO**



CON CAJA INCLUIDA
No bolsas o sacos



LAVADO RÁPIDO
Con manguera



CANALES DE DRENAJE
Dirige agua y suciedad

LAS IMÁGENES SON REFERENCIALES, CONSULTAR CON SU ASESOR DE VENTAS

MODELOS COMPATIBLES



TRAKKO

PORTAEQUIPAJES

NEGRO BRILLANTE | FIBRA DE CARBONO



UNIVERSAL



CALIDAD



RESISTENTE



SEGURIDAD



ACABADOS DIFERENCIADOS



NUEVA APERTURA DUALSIDE

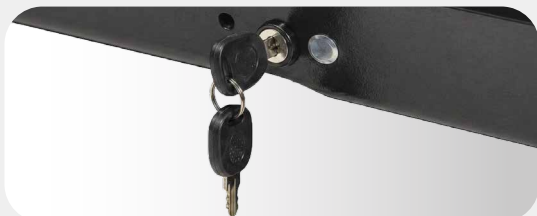

SISTEMA DE CIERRE SEGURO



AMPLIA CAPACIDAD INTERNA

LAS IMÁGENES SON REFERENCIALES, CONSULTAR CON SU ASESOR DE VENTAS

MODELOS COMPATIBLES

TRAKKO



MODELO TR-460

COD: 496

AGOTADO

MODELO TR-450

COD: 497

AGOTADO



MODELO TR-650

COD: 498

AGOTADO



MODELO TR-480

COD: 499

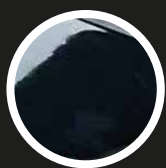

**ACABADO
NEGRO BRRILLANTE**



**ACABADO
FIBRA DE CARBONO**



TRAKKO®
FORCE

FARO

PRINCIPAL LED CROMADO



LUCES NÍTIDAS



ALTA CALIDAD



AJUSTE EXACTO



LUZ ALTA



LUZ BAJA



GRABADO HLX



GRABADO TAILANDIA

**MODELO
COMPATIBLE**



**TOY HLX
(2021-2025)**

COD: 515

FARO

DELANTERO TRILED



LUCES NÍTIDAS



ALTA CALIDAD



AJUSTE EXACTO



FULL LED



DRL

MODELO
COMPATIBLE



TOY HLX
(2012-2015)

COD: 516

BODY KIT

ACTUALIZACIÓN RVO A DISEÑO G-R

ANTES

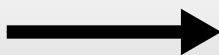

DESPUÉS



NUEVO LOOK



ALTA CALIDAD



AJUSTE EXACTO

INCLUYE:

- PARACHOQUE
- REFLECTORES
- PARRILLA
- CORRELLUVIAS
- FENDER
- LOGO TOY Y LOGO GR
- NEBLINEROS

MODELO
COMPATIBLE

TOY HLX RVO
A G-R SPORT 4 2016+
COD: 252

FARO

DELANTERO TRILED RGB

ROCO 2021+



LUCES NÍTIDAS



ALTA CALIDAD



AJUSTE EXACTO



RGB



FUNCIONES INTELIGENTES



GRABADO TAILANDIA

**MODELO
COMPATIBLE**



**TOY HLX
(2021-2025)**

COD: 520

FENDER

TRAKKO FORCE - NEGRO



HDPE

**MATERIAL
RESISTENTE**



**RESISTENTE
A RAYOS UV**



**PROTECCIÓN
DURADERA**



**AJUSTE
EXACTO**



DISEÑO FIRME Y SEGURO



CON CINTA DE SEGURIDAD

COMPATIBLE CON



FORD RANGER T9

COD: 414

PORTA

BICICLETA TRAKKO

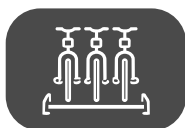

**ALTA CAPACIDAD
DE CARGA**



**RESISTENTE
AL CLIMA**



**MÁXIMA
SEGURIDAD**



**USO
UNIVERSAL**



DISEÑO PLEGABLE



FIJACIÓN SEGURA



AJUSTE EXACTO

COD:427

TRAKKO

TAPA RETRÁCTILES



**TRIPLE
SELLADO**



**AJUSTE
EXACTO**



**RESISTENTE
A RAYOS UV**



**SISTEMA
RETRACTIL**



ALUMINIO DE ALTA CALIDAD



CIERRE DE SEGURIDAD

LAS IMÁGENES SON REFERENCIALES, CONSULTAR CON SU ASESOR DE VENTAS

MODELOS COMPATIBLES



RANGER F 150 5.5 FT
COD: 248



AGOTADO

TOYOTA HILUX REVO
COD: 249



NISSAN NP300 2023+
COD: 250



FORD RANGER T9
COD: 279



NEW MAZDA 2025
COD: 450



AMAROK VW (2022)
COD: 452



MITSUBISHI L200 2025
COD: 453



TAAKKO

TAPA RETRÁCTIL ELÉCTRICA



COMPATIBLE
CON APP

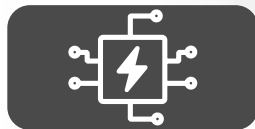

SISTEMA
ELÉCTRICO



RESISTENTE
A RAYOS UV



TRIPLE
SELLADO



LUZ INTERNA
INCORPORADA



MODO ELÉCTRICO
Y MANUAL

MODELOS COMPATIBLES



FORD RANGER T9
(NO ROLL BAR VERSION)

COD: 526



HILUX REVO 2015+

COD: 525

LAS IMÁGENES SON REFERENCIALES, CONSULTAR CON SU ASESOR DE VENTAS